

10.1" Multi-view Field Monitor

Full Horizontal & Vertical Monitoring to the Next Level



1200 nit

Touch

10.1" FHD

Multi-view

CNC Aluminum



Versatile Power Options

HDR



 ×2 + ×2
 SDI HDMI



 3D LUT

>> KEY FEATURES

- 10.1" FHD 1920x1200 IPS, view details with confidence
- Touch and physical button operation, meet different needs
- CNC aluminium alloy housing
- 1200nit high brightness, daylight viewable
- Multiple screen modes (Single, PBP, PIP, Crop, Triple, Quad)
- Load custom 3D-LUT, preview film look
- HDR monitoring, what you see is what you get
- 3-color Tally indicator, enhance the team cooperation
- Built-in cooling fan, there are 5 levels to adjust























>> Triple Power Supply Options

DC 5.5x2.1mm

LEMO 2pin

Dual NP-F Battery Slot



>> Full Range of Auxiliary Functions

 3D LUT	 HDR	 Waveform	 Vector	 Histogram	 Focus Assist
 Embedded Audio	 Over Exposure	 Check Field	 False Color	 Time Code	 Grid
 Safe Frames	 Center Marker	 Ratio Marker	 Multi Screen	 Aspect Ratio	 Anamorphic
 Image Flip	 Image Freeze	 Zoom Mode	 P2P		

>> PARAMETERS

Description	10.1" 1200nit Multi-view Field Monitor
Model	M101S
Screen size	10.1" IPS (touch)
Material	CNC Aluminium
Display Colors	10bit (8bit+2FRC)
Color Gamut	DCI-P3 95%
Resolution	1920x1200pixels
Pixel pitch	0.1128(H) x 0.1128(W) mm
Aspect Ratio	16:10
Brightness	1200 cd/m ²
Contrast	1500:1
Backlight	LED
Response Time	Ton+Toff=25ms
Viewing Angle	80°/80°(L/R) 80°/80°(U/D)
Input	2*3G-SDI, 2*HDMI, 1*Tally
Output	2*3G-SDI, 2*HDMI
Other Interface	SD Card slot (firmware update/LUT import)
Audio	3.5mm Stereo Headphone
Power In	DC IN 12V, Barrel (5.5mm outer, 2.1mm inner); LEMO 2pin
SDI Input/Output Support Format	720p(60/59.94/50/30/29/25/24/23.98)
	1080i(60/59.94/50)
	1080p(60/59.94/50/30/29.97/25/24/24sF/23.98/23.98sF)
HDMI Input/ Output Support Format	480i/576i/480p/576p
	720p (60/59.94/50/30/29.97/25/24/23.98)
	1080i (60/59.94/50)
	1080p (60/59.94/50/30/29.97/25/24/23.98)
	3840×2160p (60/50/30/29.97/25/24/23.98) 4096×2160p (60/50/30/29.97/25/24/23.98)
Power Consumption	≤ 24W
Input Voltage	DC7 ~24V
Battery Slot	Dual NP-F battery slot
Operating Temperature	-10°C ~ 60°C
Storage Temperature	-30°C ~ 70°C
Install Way	1/4"-20 Thread Point (Left, Right, Top, Bottom)
Unit Size	244x157x25.9(mm)
Unit Weight	849g

>> PACKAGING LIST

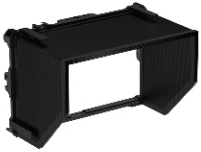
			
Monitor	HDM Cable	Micro HDMI Cable	SDI Cable
			Optional 
Tally Connector	U-shape Bracket	Quick Start Guide	Monitor Cage (with sunshade)

>> PRODUCT OVERVIEW

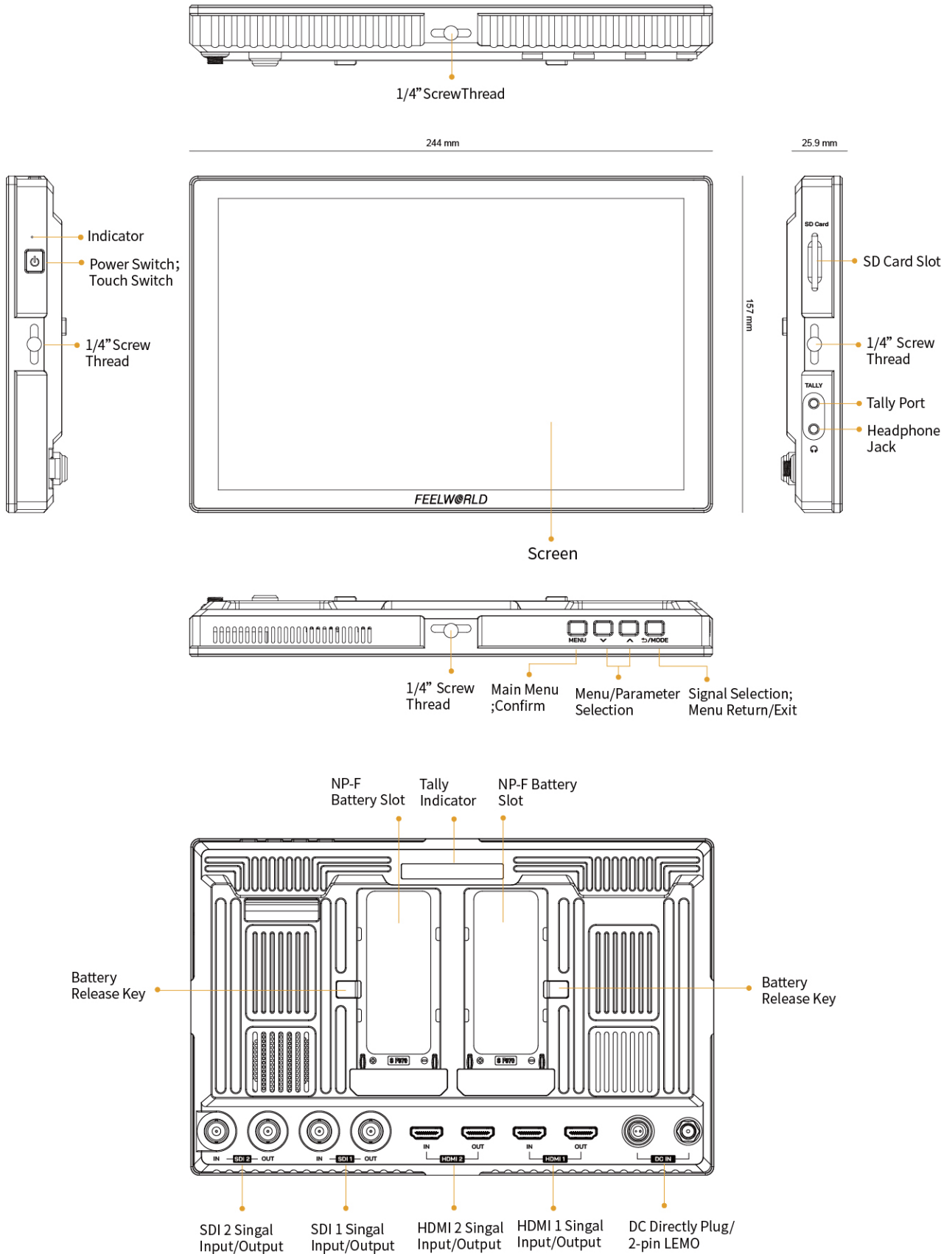

HDMI® **CE** **FC** **RoHS**

Zhangzhou Seetec Optoelectronics Technology Co., Ltd

E-mail: sales@feelworld.cn

Tel: +86-596-2182566

Website: www.feelworld.com.cn

Fax: +86-596-2672617

www.seetec.com.cn