

7" Touchscreen Field Monitor



User Manual

Foreword

Thank you for purchasing our 7" touchscreen field monitor. Please read this manual carefully before using the unit. Have a great experience!

Cautions

- Please avoid the heavy impact and drop onto the ground when move the product.
- The screen of this product is made of glass. Please do not drop the screen towards the ground. Keep away from injury if the screen is broken.
- Keep the product away from the heat source, and avoid the prolonged exposures to the sun as the LCD screen will be damaged.
- To avoid damaging the product, please do not take apart or repair the unit by yourself without the adjustable components in the unit.
- In order to better maintain the LCD screen and protect the cover, please follow the following ways to avoid damages.
 1. Please refrain from using the hard objects to hit the screen.
 2. Please do not force to wipe the screen.
 3. Please do not use the chemical solutions to clean the screen.
 4. Please do not spray any detergent on the screen.
 5. Please do not write on the screen directly.
 6. Please do not stick on the screen.
 7. Please simply wipe with a clean soft cloth and make sure no water on the screen.

Key Features

- HD 1280x800 IPS, present clearly image

- Full touch screen, easy to setup
- Slim and lightweight design
- Three F shortcut buttons can be self-defined for different function
- 4-group user switching, quickly access the already set menu
- 9:16 Vertical safety frame and ratio marker, ideal for Tik Tok, Instagram
- 3.5mm earphone output for real-time monitoring

CONTENTS

1. Product Profile	4
2. Power Supply Way	5
3. Connection Method and Cautions for Monitor and Camera	6
4. Installation of Mini Hot Shoe Mount Adapter	9
5. Installation of Sunshade	11
6. Menu and Button Operation Instruction	11
7. Menu Function Instruction	14
8. Firmware Update	19
9. Technical Parameters	19
10. Trouble Shooting	21

1. Product Profile

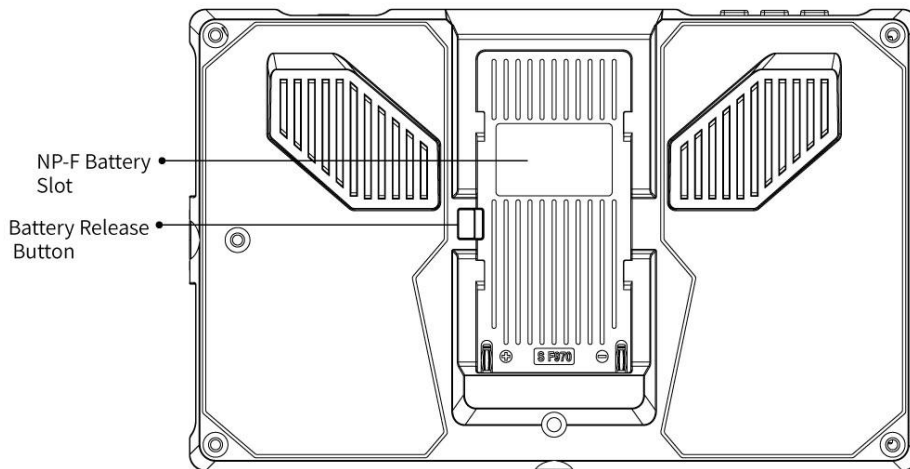
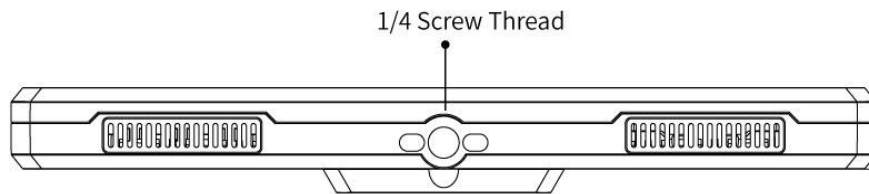
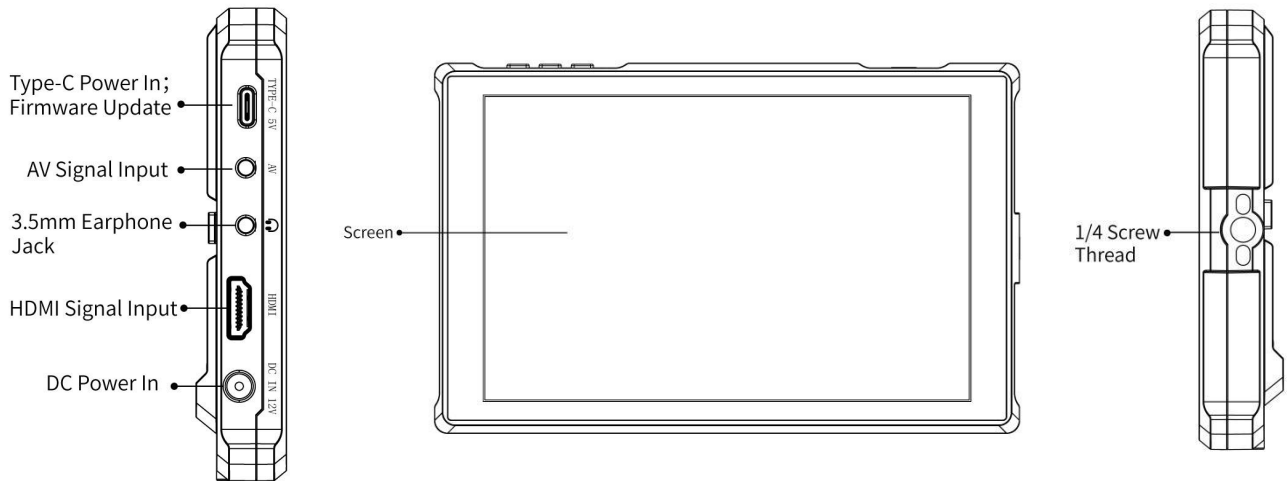
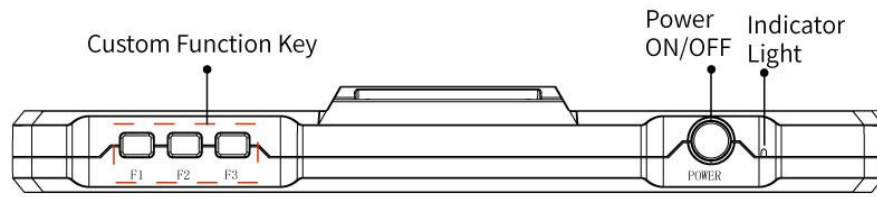

1.1 Plug Configuration of AV Cable Instruction

The AV signal port of the monitor need to use 3.5mm four-section plug, please make sure the plug configuration is same as below diagram when purchasing the AV cable.

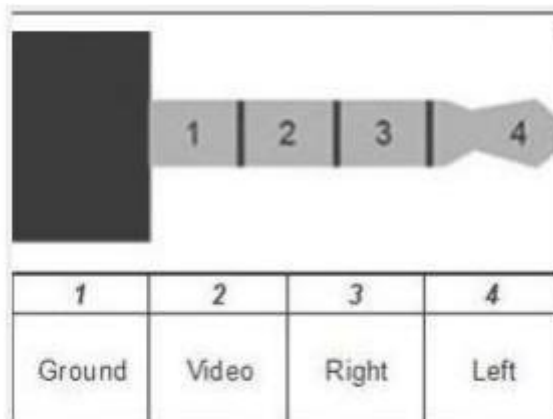

2. Power Supply Way

There are three power supply ways to the monitor:

A. Barrel (5.5mm outer, 2.1mm inner) at the left side of the monitor, DC 7~24V Input. It is recommend to use 12V/1A or 1.5A power adapter

B. The left side of the monitor has a Type-C 5V input power port.

This port can be connected to the power bank for power supply and is not used for data transmission; it is recommended to be used only for local power supply, and it is not recommended to connect other devices to provide loop-out power. Please use 5V/2A or more than 2A Type-C power supply.

C. The rear cover of the monitor is equipped with NP-F battery slot, it can

be installed the NP-F series battery

The battery models including F970 F960 F950 F930 F770 F750 F730 F570
F550 F530 and other specifications.

**Remark: Please take off the battery from the monitor if you don't use
the monitor in a long time.**

● **Installation and remove of battery**

(1) . Insert the battery gently in the direction indicated, then slide it to the
down (without releasing). A clicking sound indicates that the battery is
securely in place.

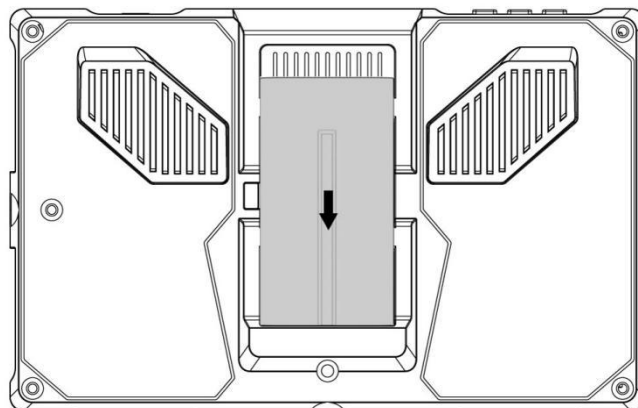

(2) . To remove the battery,press and hold the battery release button
while slide the battery to the up, then remove it.

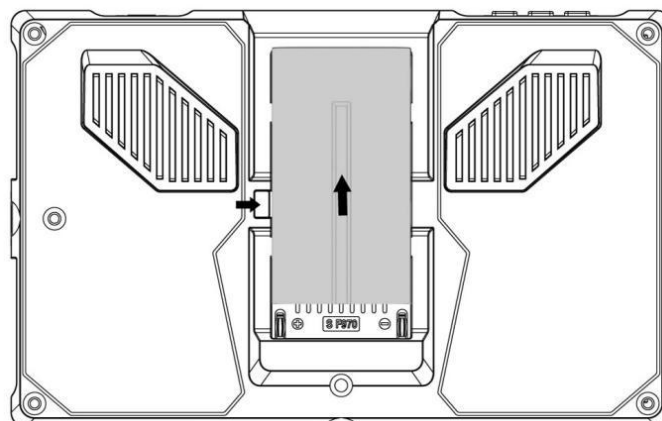

3. Connection Method and Cautions for Monitor and Camera

Preparing before connecting

- Ensure that both the camera/camcorder and monitor are turned off
- Check if the HDMI interface and cables are clean and intact
- Prepare anti-static wristbands or discharge by touching metal object first
- Ensure that the workbench is clean and stable

Connection of HDMI cable

- ①. Using the accompanied HDMI/Micro HDMI cable to connect the HDMI IN of the monitor and the HDMI Out of the camera (please purchase extra HDMI cable if the HDMI cable is not long enough)
- ②. Fix the wire to avoid hanging or pulling it
- ③. Turn on the camera first, and then turn on the monitor. The image of camera viewfinder will be displayed on the screen of the monitor.

Please set it to Auto or 16:9 if the camera is designed with an HDMI output setting function.

- ④. When shutting down, first turn off the monitor, wait for it to completely shut down, and then turn off the camera.

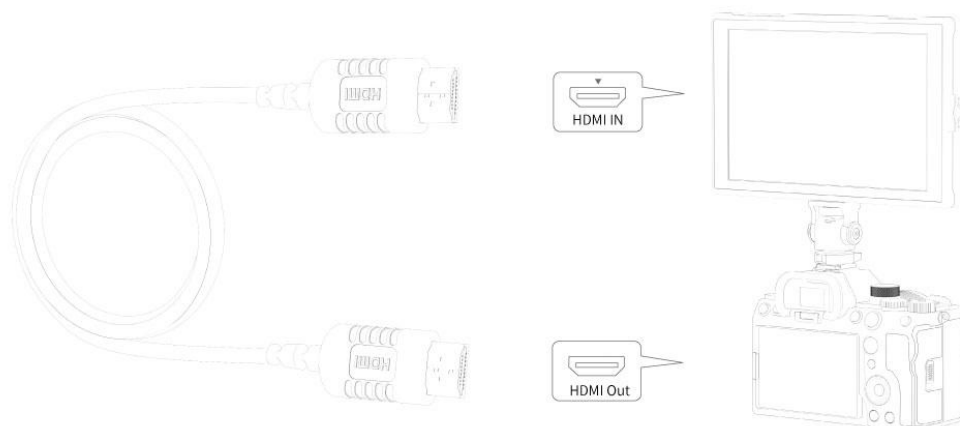

Using cautions

- When moving the device, be careful not to trip over the wires, which may cause hot plugging or unplugging
- Regularly check whether the HDMI interface and HDMI cables are worn or blocked by foreign objects
- It is recommended to disconnect when not in use to protect the cables and interfaces

Physical protection measures

- Use HDMI cable fixing clips or brackets
- The wire should have an appropriate margin to avoid being too tight
- Consider using an L-shaped HDMI connector to reduce the pressure on the HDMI interface
- You can use an HDMI adapter to protect the HDMI interface on the camera and avoid damage to the HDMI interface caused by frequent plugging and unplugging

Regular maintenance

- Check if there is dust accumulation on the interface
- Is the equipment voltage stable
- Confirm that the wire is not damaged or bent
- Is the fixing device still securely fastened
- Are all screws securely fastened

These measures can significantly reduce the risk of equipment damage and extend its service life.

4. Installation of Mini Hot Shoe Mount Adapter

- ①. Select the direction in which the adapter is mounted according to the shape of hot shoe on the camera

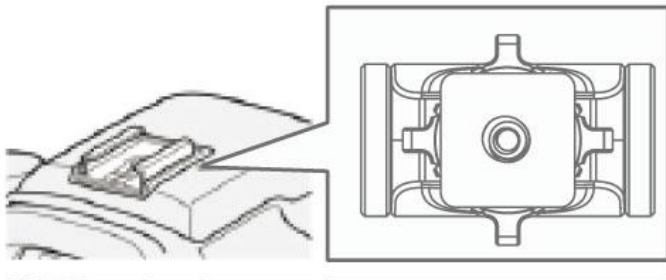

- ②. Align the 1/4 screw of the adapter with the 1/4 screw hole on the device.

- ③. Tighten the adjustment knob of the adapter

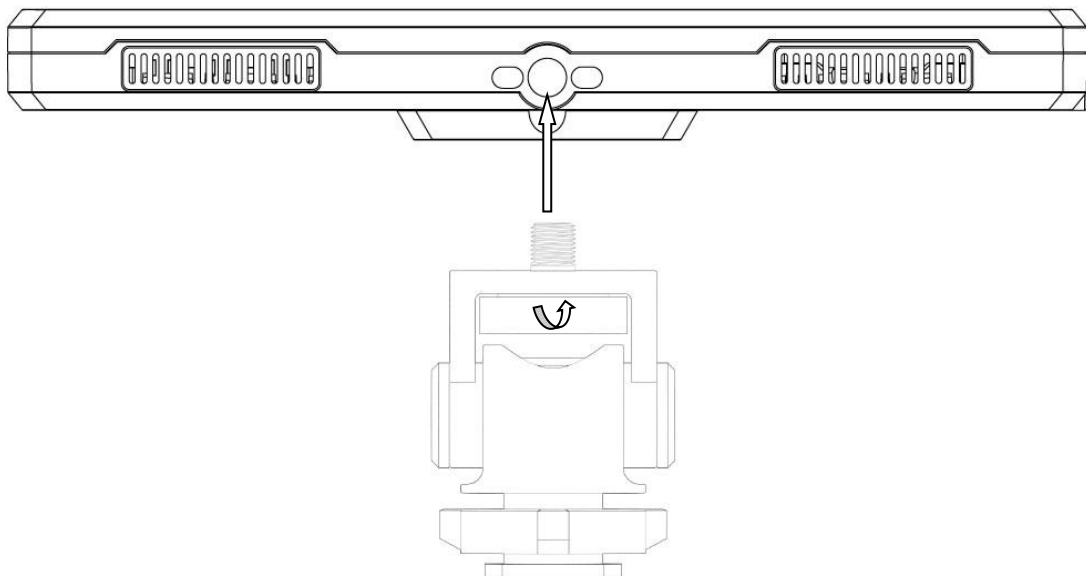

④.- Fully insert the base of the adapter into the universal hot shoe base in the direction shown in the figure.

-Tighten the rotary table of the adapter to fix it on the camera

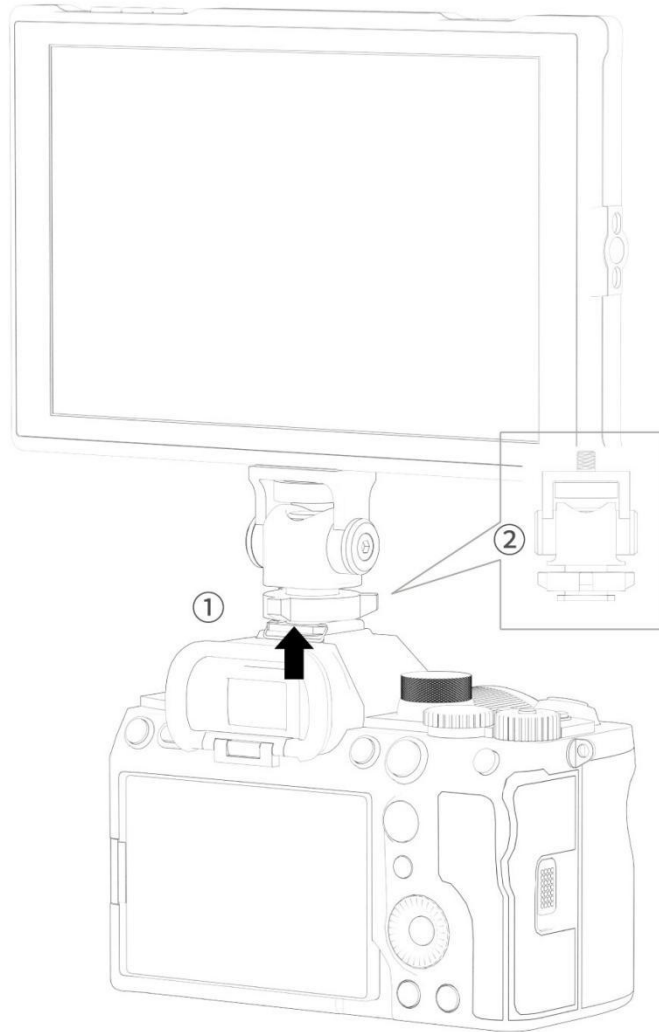

Note: If using a camera with a pop-up built-in flash, please turn off the built-in flash of camera. If the camera is designed with a built-in auto flash function, please turn off this function.

Please remove this device from the camera before using the flash.

5. Installation of Sunshade



① Sunshade



② Sunshade Frame



③ Fixed Frame



④ Sunshade Application

First lock the Sunshade Frame ② with the monitor tight ③.

Open the sunshade ①, and match the sticker on the sunshade inside to the marked part of the sunshade frame ②, smooth and press 3 sides on the sunshade, and then complete the sunshade installation ④.

6. Menu and Button Operation Instruction

After the monitor is correctly connected to the power supply, the indicator light is on (red), the monitor will turn on automatically. After the HDMI signal is input, the indicator light turns green.

After startup, short press the power button to turn off the monitor or reboot the monitor.

● Touch Screen Menu Operation

Touch function on/off setting: You can set any of the top F1~F3 of the monitor as the touch switch, enter the menu - **User Options - Shortcut Key - F1/F2/F3- Touch Switch**, and directly press the F shortcut key to turn on or off the touch function after setting.

- ①. Double-click on the screen to open the main menu (show on the left side of the screen) and click on the corresponding menu to display the secondary menu. You can enter the corresponding function option and click directly to select or set. Click the touch screen to exit the menu.
- ②. When the menu is not displayed, swipe up from the bottom of the screen to open the shortcut menu, swipe left or right select the needed function and click on the corresponding menu box to turn on or turn off the corresponding function.
- ③. When the menu is not displayed, on the left side of the screen (1/2 split screen), you can directly adjust the brightness of the screen backlight; on the right side of the screen (1/2 split screen), you can directly adjust the volume.

Figure:

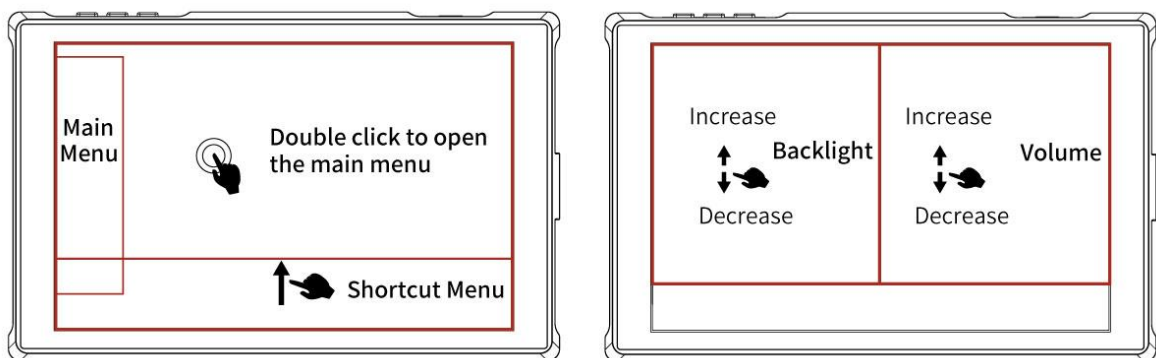

- **F1~F3 Custom Function Key**

There are three custom function keys F1~F3 on the top of the monitor, users can define the function of these keys according to their own usage habits. Enter the menu - User Options - Shortcut Key - F1/F2/F3, select the desired function inside. for example, choose "Histogram" in F1, exit the menu after selection, and press the F1 key directly to quickly call up the histogram.

- **Menu Interface**

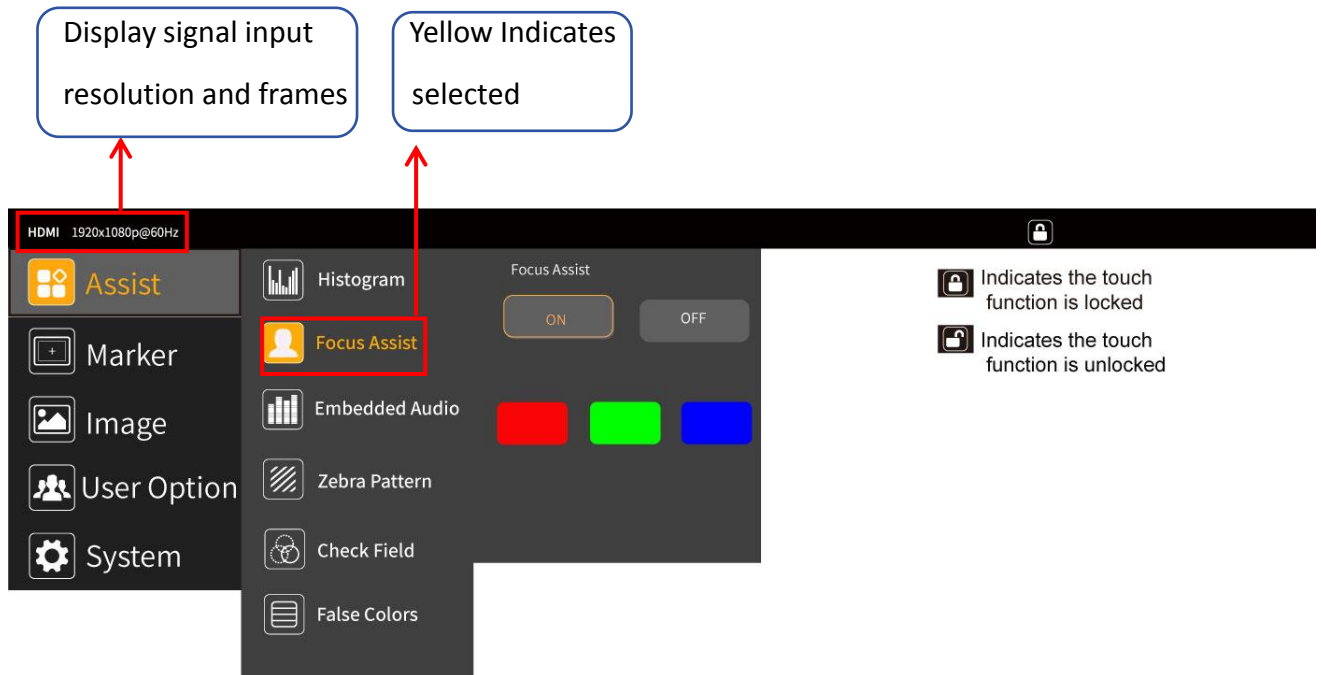





7. Menu Function Instruction



Assist



	<p>On, Off Histogram: A quantitative tool to check the picture brightness, display</p>
--	---

Histogram	different color for different brightness.
 Focus Assist	Focus Assist: On, Off Focus Color : (Red, Green, Blue) It highlights the areas that are in focus so you are able to quickly focus the camera and not miss crucial shots.
 Embedded Audio	On, Off The Audio Level Meters provide numerical indicators and headroom levels.
 Zebra Pattern	On, Off Threshold Value : you can adjust the zebra level after turning on (10~100) Areas of the image over a certain threshold are filled with a striped pattern to dramatically highlight areas where too much light is falling on the image sensor.
 Check Field	On, Off Mode : Red, Green, Blue, Gray When enabled, hue and saturation adjusted quickly and accurately
 False Color	On, Off An image that depicts an object in colors that differ from those a photograph (a true color image) would show.





Marker





 Grid	On, Off Mode: 2x2,3x3,4x4,5x5,6x6,7x7,8x8,9x9, Custom Rows: 2~9 Columns: 2~9 When selecting Custom , you can custom the rows and columns
--	---

	<p>of the grid</p> <p>Color: Red, Green, Blue, Black, White, Gray</p> <p>The area of the picture can be divided into 4, 9, 16, 25, 36, 49, 64, 81 equal grids.</p>
 <p>Safe Frames</p>	<p>On, Off</p> <p>Mode: 80%, 85%, 90%, 93%, 96%, 2.35:1, 9:16</p> <p>Color: Red, Green, Blue, Black, White, Gray</p>
 <p>Center Marker</p>	<p>On, Off</p> <p>Color : Red, Green, Blue, Black, White, Gray</p>
 <p>Ratio Marker</p>	<p>On, Off</p> <p>Mode: 4:3、 13:9、 14:9、 15:9、 16:9、 1.85:1、 2.35:1, 9:16</p> <p>Color: Red, Green, Blue, Black, White, Gray</p> <p>Modified Mark : 0~5</p>



Image



 <p>Scan Mode</p>	<p>Under Scan, Over Scan</p>
 <p>Aspect Ratio</p>	<p>Auto, 16:9, 16:10, 4:3, 5:4, 1.85:1, 2.35:1, Full Screen</p> <p>Provides a wide variety of aspect ratio to match different camera anamorphic lenses.</p>
 <p>Anamorphic</p>	<p>On, Off</p> <p>Mode: 1.33X, 1.6X, 2.0X, 2.0X MAG, User</p> <p>Under the User, can be customized (1.20X~2.00X)</p>

	Allows you to use anamorphic lenses or adapters and see the image unsqueezed, even if your camera does not de-squeeze in camera.
 Image Flip	On, Off Mode: H Flip, V Flip, H_V Flip
 Zoom Mode	On, Off Mode: 2X、4X、9X、16X、User Under the User , can be customized (100%~200%) It is HD signal in any part, an amplification for high quality close-up.
 Image Freeze	On, Off
 P2P	On, Off Enable the filmmaker to check the image from the 1:1 signal source without scaling. This feature is essential for capturing optimum detail.



User Option

 Display Adjustment	Backlight: 0~100 Adjust the screen brightness Brightness: 0~100 Adjust the image brightness Contrast: 0~100 Adjustment of the ratio between the brightest and darkest parts of the image . When adjusting, pay attention to the sense of
--	--

	<p>hierarchy in the image. If the proportion is too large or too small, it can cause the image to lose its colorful appearance.</p> <p>Saturation: 0~100</p> <p>Adjustment of color concentration</p> <p>Tint: 0~100</p>
 <p>Color Adjustment</p>	<p>Display Range: Auto, Limit, Full</p> <p>This feature allows for the selection of a grayscale range. The Limited grayscale range is 16-235, and the Full grayscale range is 0-255. (Grayscale represents changes in image brightness, using varying gray levels to depict brightness in different image areas. In grayscale, brightness increases from black to white, typically denoted by a numerical range from 0 to 255, where 0 signifies black and 255 indicates white, and intermediate numbers indicate varying grayscale levels.)</p> <ol style="list-style-type: none"> 1. If the dark part of the picture lost, the details cannot be seen clearly. For example, the input signal is in the range of 0-255, but the monitor is set Auto or Limit, the brightness of 0-15 and 236-255 is removed, resulting the dark part details unclear. You can set to Full. 2. If the picture is gray, the black part turned gray. For example, the input signal is in the range of 16-235, but the monitor is set Full , resulting the black part turn gray. At this time,you can set to Auto or Limit. <p>Color Temp.: 5600K, 6500K, 9300K, User</p> <p>Under the User, the red, green and blue of the image can be adjusted (0~255), made the colors of the image achieve your favorite.</p>
	<p>Aspect Ratio, Image Flip, Ratio Marker, Histogram, Embedded Audio, Center Marker, Safe Frames, Grids, Safe Frames, Grids, Focus Assist, False Colors, Zebra Pattern, Anamorphic,</p>

Shortcut Key	Image Freeze, Check Field, Zoom Mode, Touch Switch, Input Source
---------------------	--



System

 User Switch	User Switch: 1~4 you can save the set menu as 1-4 and can be called directly next time
 Language	English, 简体中文, Español, Português, Français, Nederlands、Deutsch, 日本語, 繁體中文, 한국어로, русский язык , Italiano
 OSD Option	OSD Time: Off, 15Sec, 30Sec, 45Sec Select the display time of the menu on the screen OSD Trans: Off, 25%, 50%, 75% Adjust the transparency of the menu picture background on the screen No Signal: Red, Green, Blue, Black, White, Gray Can be change the background color of screen when no signal
 Input Source	HDMI, AV
 Volume	On, Off 0~100 Adjusting the speaker volume
 	Select Reset and press MENU button Confirm , the system back

Reset	to original setting.
 Firmware Update	Firmware Version (display the version number) Firmware Update Confirm

8. Firmware Update

We usually do not recommend to upgrade casually. If really need, please connect after-sale or other person to get the relevant upgrade file.

- ①. Use a USB flash driver with FAT32 format. Copy the upgrade file to the USB flash driver, then insert it to the USB-A port of USB-A to USB-C adapter
- ②. Turning on the monitor, insert the USB-A to USB-C adapter to the Type-C port of the monitor
- ③. Enter the menu, select **System--Firmware Update--Update**, click “Confirm” to start to upgrade
- ④. The monitor will shut down automatically when finished, please reboot manually
- ⑤. Check whether the latest version

Remark: Please keep the device is powered on in the whole upgrading

9. Technical Parameters

Panel Size	7.0 inch (touch)
Resolution	1280×800 pixels
Backlight	LED
Pixel Pitch	39.25(H) x RGB x 117.75(V) mm

Colors Display	16.7M
Color Depth	8bit
Aspect Ratio	16:10
Brightness	400cd/m ²
Contrast Ratio	1000:1
Response Time	25ms
Viewing Angle	89°/89°(L/R) 89°/89°(U/D)
Input Signal	HDMI1.4, AV
Video Color	PAL-4.43 / NTSC-3.58
HDMI Support Format	480i /480p /576i /576p 720p (60/59.94/50/30/29/25/24/23.98) 1080i (60/59.94/50) 1080p (60/59.94/50/30/29.97/25/24/24sF/23.98/23.98sF) 4K UHD 3840×2160p (30/29.97/25/24/23.98) 4096×2160p (24Hz)
Headphone	stereo 3.5mm
Power Input	DC IN 12V, Barrel (5.5mm outer, 2.1mm inner) Type-C 5V Note: please use 5V/2A or more than 2A Type-C power supply
Input Voltage	DC 7~24V
Power	≦ 9W
Unit Size (mm)	182Lx115Hx22D mm
Unit Weight	300g
Installation	2 ¼-20 thread points (bottom, right side)
Working	- 20 ~ 50°C
Storage	- 30 ~ 60°C

10. Trouble Shooting

1. Only black and white or monochrome picture:

- ① please check saturation, brightness & contrast adjustment.
- ② Please check "Check Field" is in black, white or monochrome image or other condition.

2 .NO Image after put on the power

- ① Check if signal cable connecting is in good condition.
- ② Check signal cable connecting, and make sure to use the standard adapter to connect the monitor. If power is supplied by battery, please check if the battery is fully charged.

3. Earphone No sound

Check if Volume control do not open, press the volume button, and try to increase the volume.

- If there are still other problems, please contact with our related technologists.

★ As we are improving product features and product performance, so if there is any change on the specification without prior notice.