

7" 10BIT FIELD MONITOR

2000nits |AG+AF Coating|DCI-P3

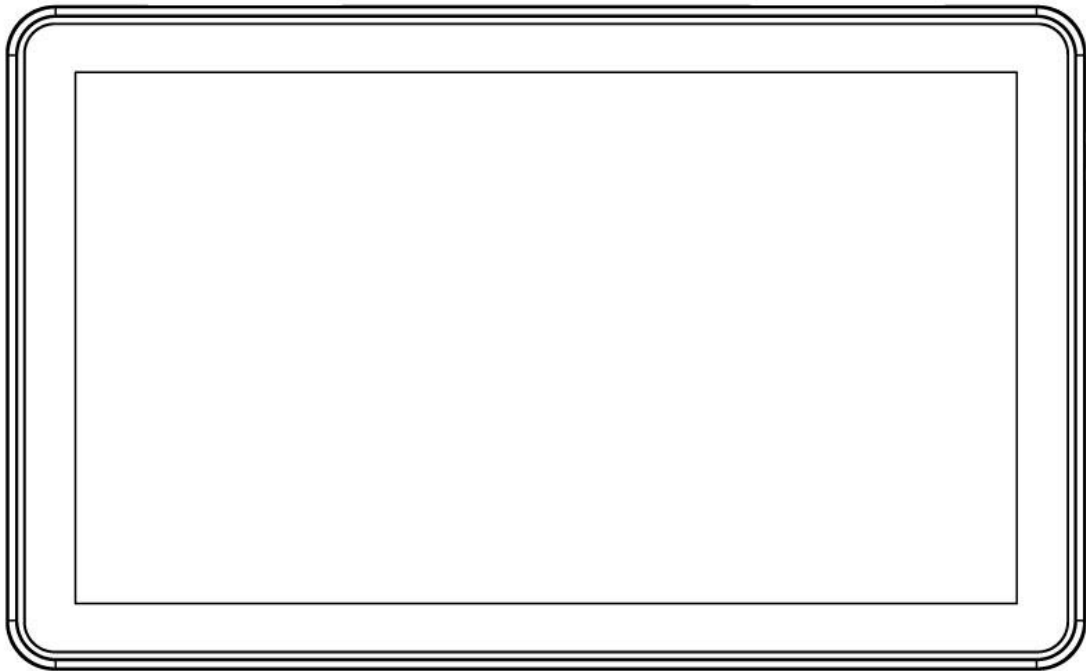

User Manual

Foreword

Thank you for using our 7- inch 10bit field monitor. Please read this manual carefully before using the unit. Have a great experience!

Cautions

1. Please avoid drop onto the ground and lead to the device broken when move the product.
2. The screen of this product is made of glass, please keep away from injury if the screen is broken.
3. Keep the product away from the heat source. Avoid the prolonged exposures to the sun as the LCD screen will be damaged.
4. To avoid damaging the product, please do not take apart or repair the unit by yourself without the adjustable components in the unit.

- To protect the screen or housing better, please follow these ways as below to avoid the damages:

Please refrain from using the hard objects to hit the screen

Please do not force to wipe the screen or housing

Please do not use the chemical solutions to clean the screen or housing

Please do not spray any detergent on the screen or housing

Please do not write on the screen directly

Please do not stick anything on the screen or housing

Please simply wipe with a clean soft cloth and make sure no water on the screen or housing

Key Features

- FHD 1920x1080 IPS, view details with confidence
- 10-bit high color depth ensures smooth and natural color transition with delicate layered visuals and no color banding.

- AG +AF coating effectively reduces ambient glare and reflection. It delivers clear and vivid visuals, eases eye strain and relieves visual fatigue, leaving no fingerprints on the screen surface.
- Sensitive touch screen+innovative and flexible knob operation to meet different needs
- 2000nit high brightness, visible in sunlight
- Equipped with 4K 60Hz HDMI,3G-SDI (optional) input and output
- Load custom 3D-LUT, preview film look
- HDR monitoring, what you see is what you get
- Waveform, Vector, Histogram and audio meter can moveable horizontally and vertically
- 4-group user switching, quickly access the already set menu
- 3.5mm earphone output for real-time monitoring

CONTENTS

1. Product Overview	4
2. Power Supply Way	5
3. Connection Method and Cautions for Monitor and Camera	6
4. Installation of Mini Hot Shoe Mount Adapter	9
5. Installation of Sunshade	11
6. Menu and Button Operation Instruction	11
7. Menu Function Instruction	14
8. How to Import Custom LUT	21
9. Firmware Update	22
10. Technical Parameters	23
11. Trouble Shooting	24

1. Product Overview

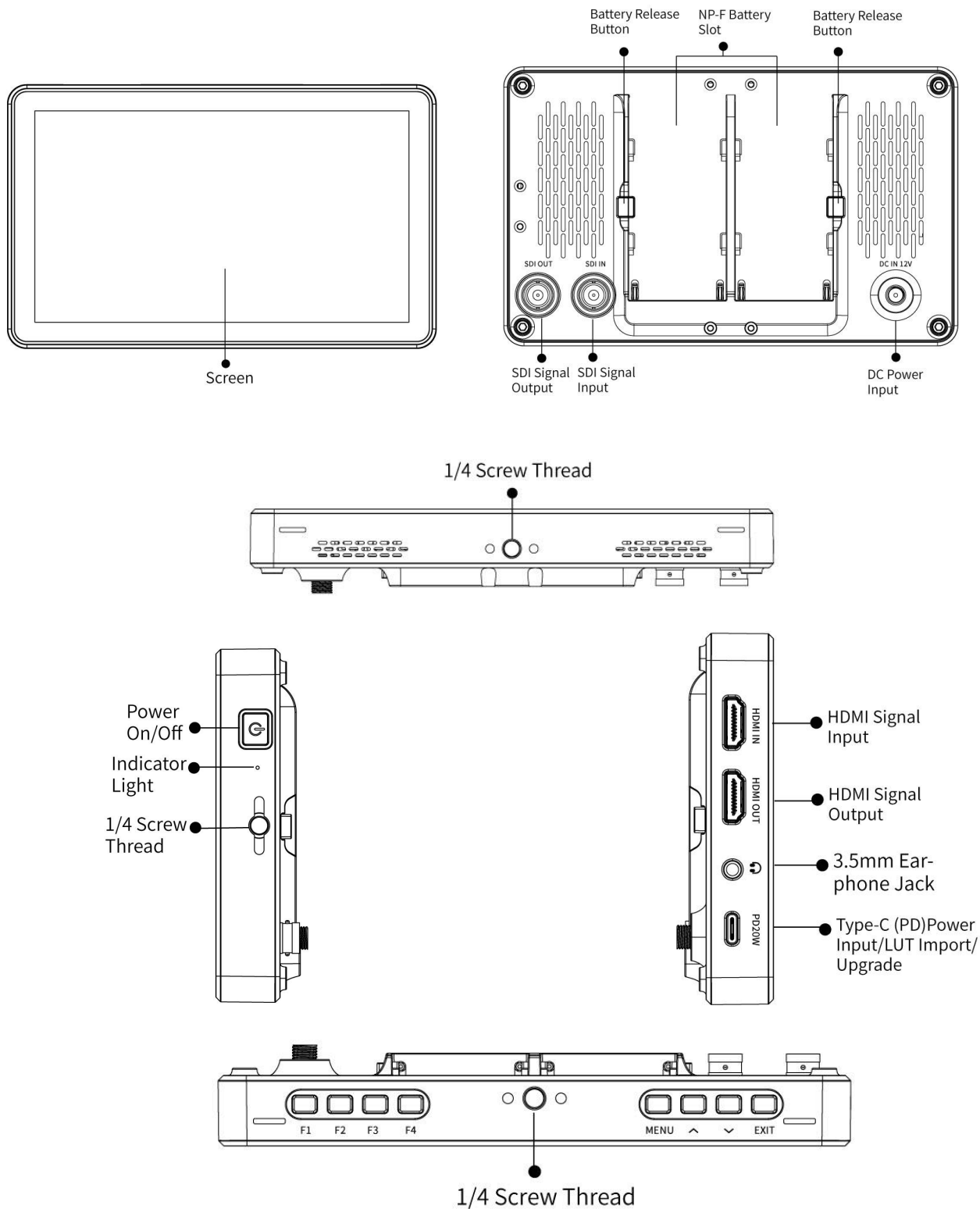

Button	Function when OSD is not displayed	Function when OSD is displayed
F1	Custom button F1	/

F2	Custom button F2	/
F3	Custom button F3	/
F4	Custom button F4	/
MENU	Display OSD Main menu	Confirm
∧	Increase the volume or backlight	Select previous menu item; Increase or adjust value of selected parameter
∨	Decrease the volume or backlight	Select next menu item; Decrease or adjust value of selected parameter
EXIT	Return/Exit Menu	

2. Power Supply Way

There are three power supply ways to the monitor:

- A. Barrel (5.5mm outer, 2.1mm inner) at the rear of the monitor, DC 7~24V Input. It is recommend to use 12V/2A power adapter
- B. Equipped with Type-C (PD) 20W power input on the left side of the monitor, it supports PD fast charging protocol and is compatible with Type-C PD chargers.
- C. The rear cover of the monitor is equipped with dual NP-F battery slots, can be installed the NP-F series battery

The battery models including F970 F960 F950 F930 F770 F750 F730 F570 F550 F530 and other specifications.

●Installation and remove of battery

①. Insert the battery gently in the direction indicated, then slide it to the downward (without releasing). A clicking sound indicates that the battery is securely in place.

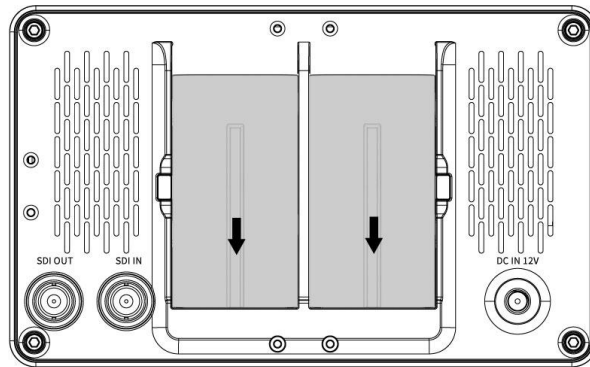

②. To remove the battery, press and hold the battery release button while slide the battery to the upper, then remove it.

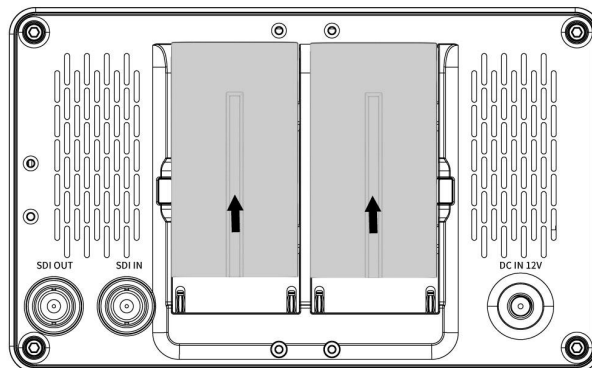

Remark: It is recommended to use standard original F970 batteries. Different specifications of the battery have different capability. The working time for the monitor will be different. Higher capability (working time) will be longer. Please take off the battery from the monitor if you don't use the monitor in a long time.

3. Connection Method and Cautions for Monitor and Camera

Preparing before connecting

- Ensure that both the camera/camcorder and monitor are turned off

- Check if the HDMI/SDI interface and cables are clean and intact
- Prepare anti-static wristbands or discharge by touching metal object first
- Ensure that the workbench is clean and stable

Connection of HDMI cable

- ①. Using the accompanied HDMI/Micro HDMI cable to connect the HDMI IN of the monitor and the HDMI Out of the camera (please purchase extra HDMI cable if the HDMI cable is not long enough)
- ②. Fix the wire to avoid hanging or pulling it
- ③. Turn on the camera first, and then turn on the monitor. The image of camera viewfinder will be displayed on the screen of the monitor.

Please set it to Auto or 16:9 if the camera is designed with an HDMI output setting function.

- ④. When shutting down, first turn off the monitor, wait for it to completely shut down, and then turn off the camera.

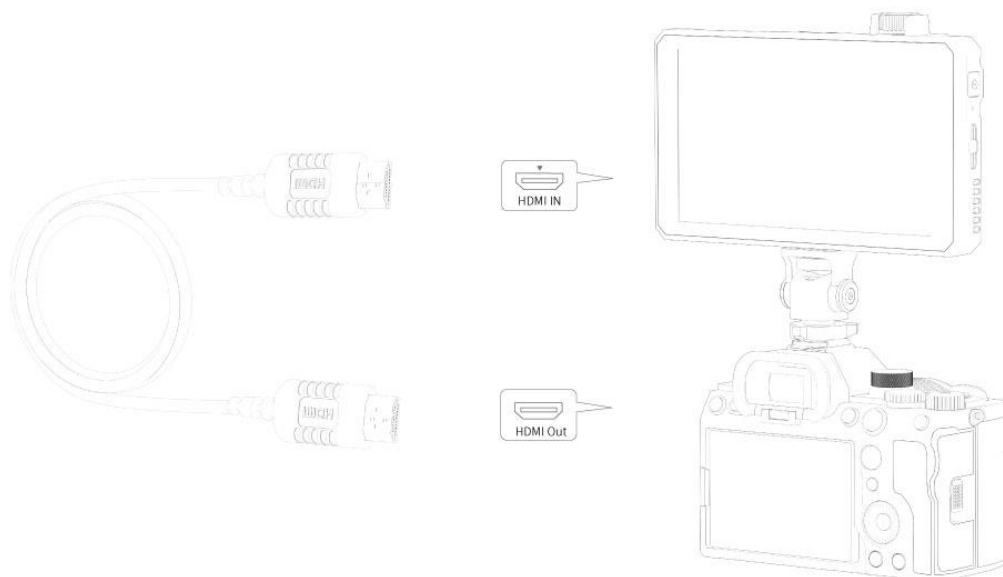

Connection of SDI cable (available separately)

- ①. Using the SDI cable to connect the SDI IN of the monitor and the SDI Out of the camcorder.
- ②. Fix the wire to avoid hanging or pulling it
- ③. Turn on the camcorder first, and then turn on the monitor. The image of camcorder will be displayed on the screen of the monitor.
- ④. When shutting down, first turn off the monitor, wait for it to completely shut down, and then turn off the camera.

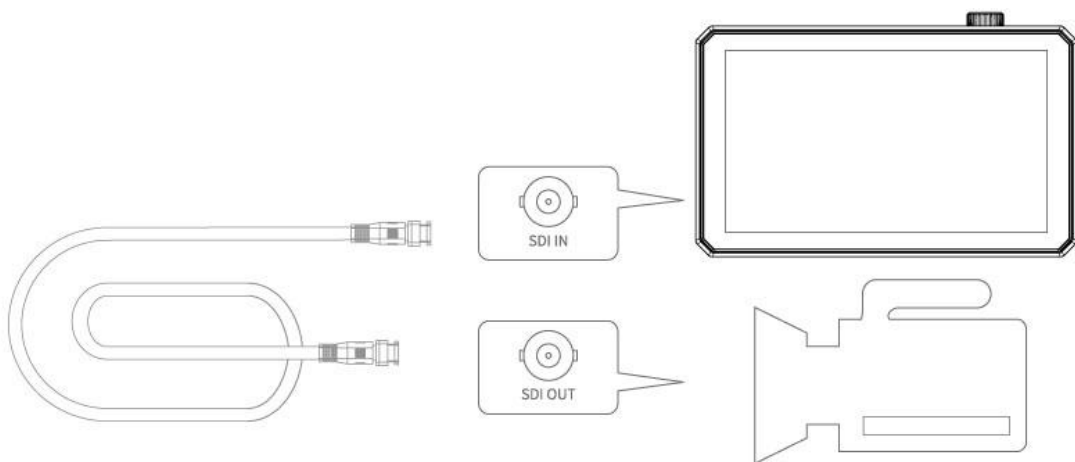

Using cautions

- When moving the device, be careful not to trip over the wires, which may cause hot plugging or unplugging
- Regularly check whether the HDMI/SDI interface and HDMI/SDI cables are worn or blocked by foreign objects
- It is recommended to disconnect when not in use to protect the cables and interfaces

Physical protection measures

- Use HDMI cable fixing clips or brackets
- The wire should have an appropriate margin to avoid being too tight

-Consider using an L-shaped HDMI connector to reduce the pressure on the HDMI interface

-You can use an HDMI adapter to protect the HDMI interface on the camera and avoid damage to the HDMI interface caused by frequent plugging and unplugging

Regular maintenance

-Check if there is dust accumulation on the interface

-Is the equipment voltage stable

-Confirm that the wire is not damaged or bent

-Is the fixing device still securely fastened

-Are all screws securely fastened

These measures can significantly reduce the risk of equipment damage and extend its service life.

4. Installation of Mini Mount Adapter

4.1. Select the direction in which the adapter is mounted according to the shape of hot shoe on the camera

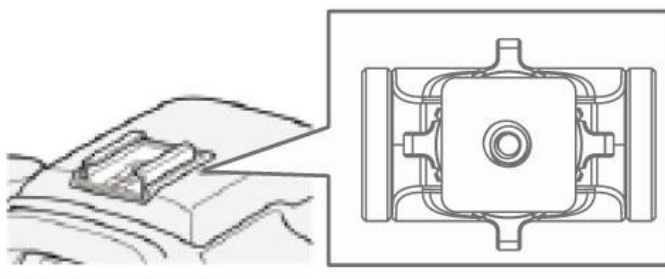

4.2. Align the 1/4 screw of the adapter with the 1/4 screw hole on the device.

4.3. Tighten the adjustment knob of the adapter

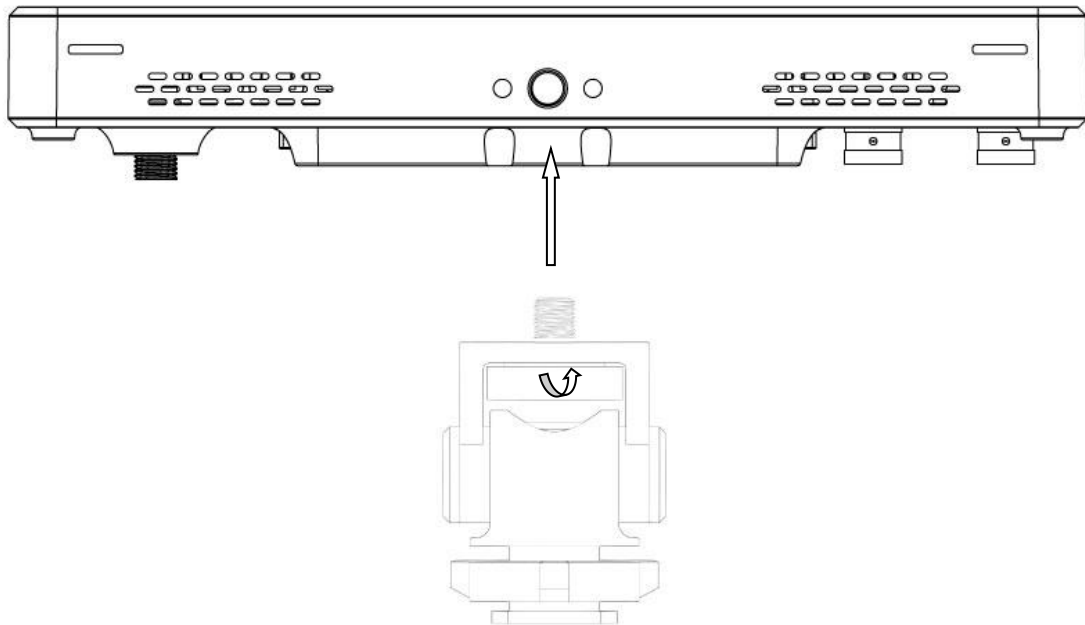

4.4. ① Fully insert the base of the adapter into the universal hot shoe base in the direction shown in the figure.

② Tighten the rotary table of the adapter to fix it on the camera

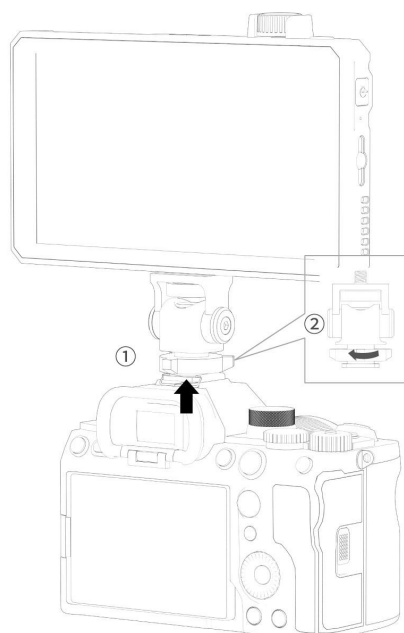

Note: If using a camera with a pop-up built-in flash, please turn off the built-in flash of camera. If the camera is designed with a built-in auto flash function, please turn off this function.
Please remove this device from the camera before using the flash.

5. Installation of Sunshade



① Sunshade



② Sunshade Frame

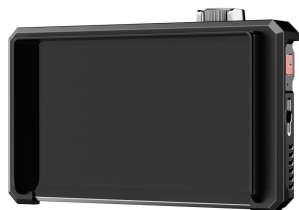

③ Fixed Frame

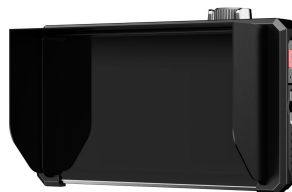

④ Sunshade Application

First lock the Sunshade Frame ② with the monitor tight ③.

Open the sunshade ①, and match the sticker on the sunshade inside to the marked part of the sunshade frame ②, smooth and press 3 sides on the sunshade, and then complete the sunshade installation ④.

6. Menu and Button Operation Instruction

After correctly connect to the power supply (red indicator), the monitor default to turn on automatically, the indicator turns Yellow, and then input HDMI signal, the indicator will turn Green from Yellow.

You can also set the power to Manually in menu **System--Power setting**. After setting, you need to long press  to turn on the monitor when plug the power supply.

6.1 MENU Knob Operation

6.1.1. When the menu is not displayed, directly press \wedge or \vee key to adjust the volume or backlight. You can set in the **Left Right Key**



6.1.2. Press **MENU** key to enter OSD main menu, then press \wedge or \vee key to select the secondary menu

6.1.3. Press **MENU** key to enter the secondary menu, then press \wedge or \vee key to select items, after selected press the **MENU** key to confirm and enter function menu, press \wedge or \vee key to select the corresponding function or adjust the parameters, press the **MENU** key to confirm finally.

6.1.4. Press **EXIT** button to return / exit the menu

6.2 Touch Screen Menu Operation

Touch function on/off setting: You can set any of the top F1~F4 of the monitor as the touch switch, enter the menu - **User Options** -

Shortcut Key - F1/F2/F3/F4- Touch Switch, and directly press the F shortcut key to turn on or off the touch function after setting.

6.2.1. Double-click on the screen to open the main menu (show on the left side of the screen) and click on the corresponding menu to display the secondary menu. You can enter the corresponding function option and click directly to select or set. Click the touch screen to exit the menu.

6.2.2. When the menu is not displayed, swipe up from the bottom of the screen to open the shortcut menu, swipe left or right select the needed function and click on the corresponding menu box to turn on or turn off the corresponding function.

6.2.3. When the menu is not displayed, on the left side of the screen (1/2 split screen), you can directly adjust the brightness of the screen backlight; on the right side of the screen (1/2 split screen), you can directly adjust the volume.

Figure:

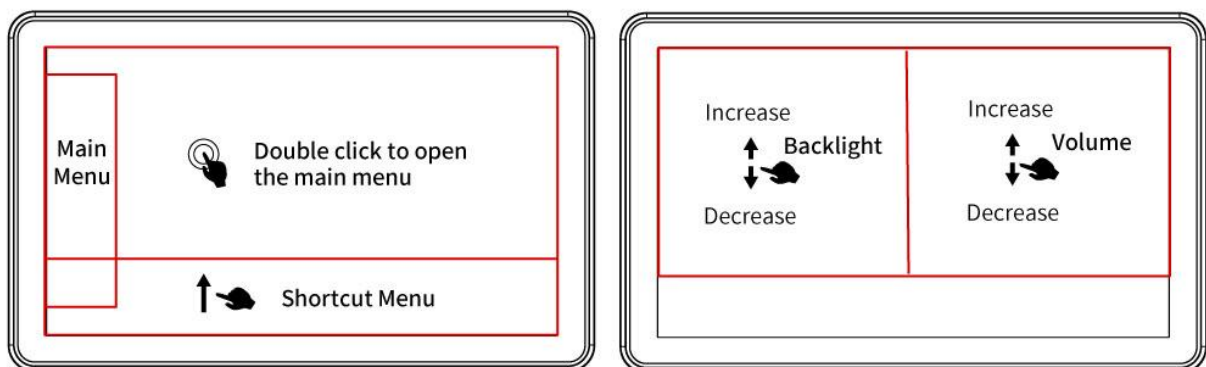

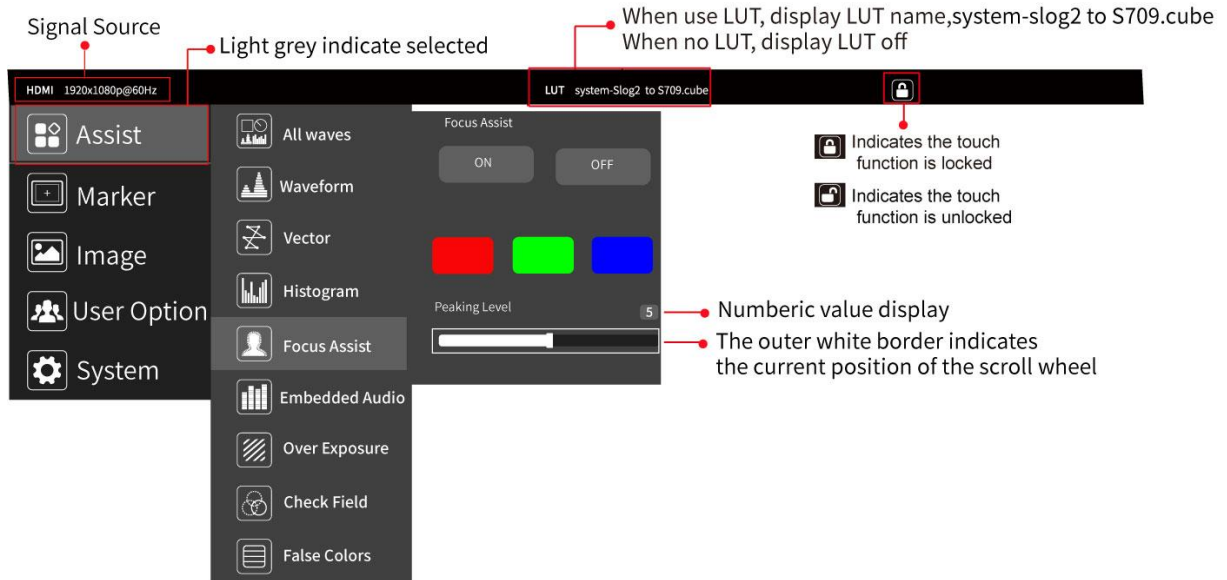

6.3 Menu Interface







7. Menu Function Instruction





Assist

 <p>All Waves</p>	<p>On, Off</p> <p>After turning on, waveform, vector, histogram and embedded audio will be shown.</p>
 <p>Waveform</p>	<p>On, Off</p> <p>Mode: RGB, YUV, Y</p> <p>Position X: 0~100 (moving the waveform horizontally)</p> <p>Position Y: 0~100 (moving the waveform vertically)</p> <p>Waves Trans.: Off, 25%, 50%, 75%</p> <p>The waveform is a core tool for professional video production. It converts the brightness and color information of the frame into visual curves, enabling precise control of exposure, white balance and color balance, preventing overexposure, crushed blacks or color casts in the frame, ensuring the signal meets</p>





	<p>broadcast standards. It is ideal for scenarios with vary light, complex composition or cinematic video.</p> <p>The X-axis of the waveform monitor corresponds to the horizontal position of the frame (left to right), and the Y-axis represents the brightness level of each position, generally defined with black as the 0 line and maximum brightness as the 100 line.</p> <p>Luminance Waveform (Y)</p> <p>Display: A white/gray curve representing the overall brightness distribution of the frame.</p> <p>RGB Component Waveform</p> <p>Display: Independent red, green and blue channel waveform, presented side by side.</p> <p>YUV Waveform</p> <p>Separates color and luminance. Y represents the luminance signal, while U and V represent the blue-yellow and red-green chrominance signals respectively.</p>
 <p>Vector</p>	<p>On, Off</p> <p>Position X: 0~100 (moving the Vector horizontally)</p> <p>Position Y: 0~100 (moving the Vector vertically)</p> <p>The vector scope is a professional tool dedicated to analyzing and monitoring the color information of a frame. It visualizes color saturation (vividness) and hue (tone) via chrominance signals in a circular graph to quantify the color data of the frame, enabling precise judgment for cinematographers and colorists. It serves as a color calibration benchmark for professional scenarios such as film and television production, live streaming, and broadcasting.</p>
 <p>Histogram</p>	<p>On, Off</p> <p>Mode: RGB1、RGB2、Y</p> <p>Position X: 0~100 (moving the histogram horizontally)</p>

	<p>Position Y: 0~100 (moving the histogram vertically)</p> <p>RGB1 Histogram:Displays the brightness distribution of the red, green, and blue channels separately, designed to judge color casts, monochromatic over/underexposure, white balance, and color gradation.</p> <p>RGB2 Histogram:The red, green, and blue channels are overlaid on the same coordinate system, with overlapping areas showing mixed colors</p> <p>Y Histogram: A tool for objectively judging exposure and tonal distribution. Ideal for monitoring overall exposure to prevent clipped highlights and crushed blacks, assisting with precise lighting setup and post-production.</p>
 <p>Focus Assist</p>	<p>On, Off</p> <p>Color: (Red, Green, Blue)</p> <p>Peaking Level: you can adjust the peaking level after turning on (1 ~ 10)</p> <p>Highlights the in-focus areas of the image to help photographers quickly and accurately judge focus position during manual focusing. Especially ideal for fast moving video, portrait, etc.</p>
 <p>Embedded Audio</p>	<p>On, Off</p> <p>Position X: 0~100 (moving the audio level horizontally)</p> <p>Position Y: 0~100 (moving the audio level vertically)</p> <p>A visual audio level indicator tool for monitors that displays sound volume in real time and detects audio clipping (distortion). It resolves issues of being unable to hear audio while monitoring video or inaudible sound in noisy environments, ensuring audio-video synchronization and distortion-free recording. Ideal for live streaming, on-location shooting and filming in noisy settings.</p>
	<p>On, Off</p> <p>Threshold Value: you can adjust the threshold value after</p>

<p>Zebra Pattern</p>	<p>turning on (10~100)</p> <p>A real-time exposure assist tool that highlights overexposed areas in the frame with striped patterns for quick identification of blown-out highlights, ensuring accurate exposure, ideal for video shooting, portrait photography and outdoor high-light scenarios.</p>
<p></p> <p>Check Field</p>	<p>On, Off</p> <p>Mode: Red, Green, Blue, Mono</p> <p>Eliminate color interference, focus on exposure, focus, contrast and single-channel signal quality, and quickly judge the picture's brightness gradation, edge details and color channel issues.</p>
<p></p> <p>False Colors</p>	<p>On, Off</p> <p>Mode: Normal, ARRI</p> <p>False Color is an exposure assist tool that maps the precise brightness value of every pixel in the frame to distinct colors corresponding to different brightness levels. It allows you to instantly check the exact exposure values across the entire frame and clearly visualize the light and shadow distribution of each specific area. Ideal for video shooting, portrait photography and outdoor shooting in complex lighting conditions.</p>
<p></p> <p>Time Code</p>	<p>On, Off</p> <p>Mode: LTC, VITC</p> <p>Consistent with the camcorder time-code, it consists of four sets of numbers representing hours, minutes, seconds and frames respectively. The time-code enables quick positioning of a specific frame in the video. In post-production multi-camera editing, video footage shot by different cameras at the same moment can be rapidly aligned via the time-code function, greatly saving post-editing time.</p>







Marker



 <p>Grids</p>	<p>On, Off</p> <p>Mode: 2x2,3x3,4x4,5x5,6x6,7x7,8x8,9x9, Custom</p> <p>Rows: 2~9</p> <p>Columns: 2~9</p> <p>When selecting Custom, you can custom the rows and columns of the grid</p> <p>Color: Red, Green, Blue, Black, White, Gray</p> <p>A core auxiliary tool for professional shooting, primarily designed for rule-of-thirds composition and horizontal/vertical calibration. It divides the screen into equal grids of 4, 9, 16, 25, 36, 49, 64 or 81 cells for optimized framing, and the number of grid rows and columns is fully customizable.</p>
 <p>Safe Frames</p>	<p>On, Off</p> <p>Mode: 80%, 85%, 90%, 93%, 96%, 2.35:1, 9:16</p> <p>Color: Red, Green, Blue, Black, White, Gray</p> <p>Prevent edge cropping of the frame, ensure subtitle/subject remain fully visible, and adapt to different playback devices.</p>
 <p>Center Marker</p>	<p>On, Off</p> <p>Color: Red, Green, Blue, Black, White, Gray</p>
 <p>Ratio Marker</p>	<p>On, Off</p> <p>Mode: 4:3, 13:9, 14:9, 15:9, 16:9, 1.85:1, 2.35:1, 9:16</p> <p>Color: Red, Green, Blue, Black, White, Gray</p> <p>Modified Mark: 0~5</p> <p>Preview the target aspect ratio in real time, standardize framing,</p>

	reduce post-production cropping, align shooting with the final footage ratio, and improve framing efficiency and footage precision.
--	---



Image



 <p>Scan Mode</p>	<p>Under Scan, Over Scan</p>
 <p>Aspect Ratio</p>	<p>Auto, 16:9, 16:10, 4:3, 5:4, 1.85:1, 2.35:1, Full Screen</p> <p>Match the shooting frame, eliminate picture distortion, and monitor precise composition to ensure the captured footage is restored without stretching or cropping in its original aspect ratio, adapting to various formats and creative requirements.</p>
 <p>Anamorphic</p>	<p>On, Off</p> <p>Mode: 1.33X, 1.6X, 2.0X, 2.0X MAG, User</p> <p>Under the User, can be customized (1.20X~2.00X)</p> <p>Paired with anamorphic lenses, this function restores the horizontally compressed shooting image to the normal aspect ratio on the monitor for real-time framing and proportion checking. It resolves the issue of image squashing and inaccurate framing when shooting with anamorphic lenses.</p>
 <p>Image Flip</p>	<p>On, Off</p> <p>Mode: H Flip, V Flip, H_V Flip</p> <p>This function resolves abnormal screen orientation caused by special monitor mounting angles (e.g., upside-down, side-mounted) or restricted shooting perspectives. It ensures a correct, upright</p>



	viewing angle for the screen regardless of the monitor's mounting or shooting position, without interfering with monitoring, focusing or framing.
 Zoom Mode	On, Off Mode: 2X、 4X、 9X、 16X、 User Under the User , can be customized (100%~200%) Magnify the central area of the screen for precise focusing, detail inspection and image quality verification.
 Image Freeze	On, Off
 P2P	On, Off A display mode that maps the monitor's input signal pixel 1:1 to its physical screen pixels, presenting the signal with no stretching, no scaling and no cropping to fully restore the original resolution and fine details of the input signal. It is an essential function for precise focusing, image quality inspection and framing calibration. Note: This function is only available when the input signal resolution \leq the monitor's physical resolution.



User Option

 LUT	On, Off After the LUT Switch is turned on, you can use the Lut (SLOG2, SLOG3, LOGC, VLOG). Lut Import: Confirm Lut Table Show the 4 built-in Lut and the custom load Lut (up to 32)
---	--









	<p>The Lut item is displayed after the Lut Switch is turned on.</p> <p>LUT is a table for quickly looking up and output specific color data. By loading different 3D-LUT tables, it can quickly recombine color tone to form different color styles</p>
 <p>HDR</p>	<p>On, Off</p> <p>Mode: HLG1, HLG2, HLG3</p> <p>HDR can provide more dynamic range and the details of image, it is better to reflect the visual effects in the real environment.</p>
 <p>Display Adjustment</p>	<p>Backlight: 0~100</p> <p>Adjust the screen brightness</p> <p>Brightness: 0~100</p> <p>Adjust the image brightness</p> <p>Contrast: 0~100</p> <p>Adjustment of the ratio between the brightest and darkest parts of the image . When adjusting, pay attention to the sense of hierarchy in the image. If the proportion is too large or too small, it can cause the image to lose its colorful appearance.</p> <p>Saturation: 0~100</p> <p>Adjustment of color concentration</p> <p>Tint: 0~100</p>
 <p>Color Adjustment</p>	<p>Display Range: Auto, Limit, Full</p> <p>This feature allows for the selection of a grayscale range. The Limited grayscale range is 64~940, and the Full grayscale range is 0-1023. (Grayscale represents changes in image brightness, using varying gray levels to depict brightness in different image areas. In grayscale, brightness increases from black to white, typically denoted by a numerical range from 0 to 1023, where 0 signifies black and 1023 indicates white, and intermediate numbers indicate varying grayscale levels.)</p>

	<p>1. If the dark part of the picture lost, the details cannot be seen clearly. For example, the input signal is in the range of 0-1023, but the monitor is set Auto or Limit, the brightness of 0-60 and 944~1023 is removed, resulting the dark part details unclear. You can set to Full.</p> <p>2. If the picture is gray, the black part turned gray. For example, the input signal is in the range of 64-940, but the monitor is set Full , resulting the black part turn gray. At this time,you can set to Auto or Limit.</p> <p>Color Temp.: 5600K, 6500K, 9300K, User</p> <p>Under the User, the red, green and blue of the image can be adjusted (0~255), made the colors of the image achieve your favorite.</p>
 <p>Shortcut Key</p>	<p>All Waves, Waveform, Vector, Histogram, Embedded Audio, Center Marker, Safe Frames, Grids, Focus Assist, False Colors, Zebra Pattern, Anamorphic, Image Freeze, Check Field, Zoom Mode, Image Flip, Aspect Ratio, Ratio Marker, LUT, Touch Switch</p>
 <p>Left Right Key Set</p>	<p>Volume, Backlight</p>



System

 <p>User Switch</p>	<p>User Switch: 1~4</p> <p>you can save the set menu as 1-4 and can be called directly next time</p>
---	---

 Language	<p>English, 简体中文, Español, Português, Français, Nederlands、 Deutsch, 日本語, 繁體中文, 한국어로, русский язык, Italiano</p>
 OSD Option	<p>OSD Time: Off, 15Sec, 30Sec, 45Sec Select the display time of the menu on the screen</p> <p>OSD Trans: Off, 25%, 50%, 75% Adjust the transparency of the menu picture background on the screen</p> <p>No Signal: Red, Green, Blue, Black, White, Gray Can be change the background color of screen when no signal</p>
 EDID Settings	<p>EDID Settings: 2.0, 1.4 Compatible with resolution of different camera/device Default to 2.0 (if set 1.4 manually, then input 4K60 signal, you need to set to 2.0 again)</p>
 Volume	<p>On, Off 0~100 Adjusting the speaker volume</p>
 Power Settings	<p>Power on: Auto, Manual Default to Auto. If set Manual, please press  key to turn on after the power plug in.</p>
 Reset	<p>Select Reset and press MENU button Confirm, the system back to original setting.</p>
 Firmware Update	<p>Firmware Version (display the version number) Firmware Update Confirm</p>

8. How to Import Custom LUT

8.1. USB flash drive format

Supports FAT32

8.2. Max Files Limit Maximum 32 Lut files

8.3. File requirements

- The LUT file format suffix should be **.cube**
- Single file not exceeded to 7.9Mb
- Support LUT-3D-Size **16,17,32,33,64,65**

Remark: LUT file name must be English or Arabic numerals

8.4. Steps for loading

8.4.1 Make sure the USB flash drive correctly connect to the monitor via the accompanied USB-A to USB-C adapter

8.4.2 Enter main menu **User Option--LUT-- LUT Import -- Confirm** to load

the monitor will auto detect the USB flash drive

If there is valid lut file in USB flash drive, the monitor will load LUT files and show “[n] name. The [n] shows the quantity number. The “name” should in LUT files’ name. If load successful, the screen will show “complete[n]”. [n] Stands for the quantity number for LUT files should under 32.

PS: How to clear up the imported LUTs?

Insert a empty USB flash drive to the monitor, enter main menu **User Option--LUT-- LUT Import -- Confirm**, the imported LUTs will be clear up.

9. Firmware Update

We usually do not recommend to upgrade casually. If really need, please connect after-sale or other person to get the relevant upgrade file

- ①. Use a USB flash drive with FAT32 format. Copy the upgrade file to the USB flash drive, then insert it to the USB-A port of USB-A to USB-C adapter
- ②. Turning on the monitor, insert the USB-A to USB-C adapter to the Type-C port of the monitor
- ③. Enter the menu, select **System--Firmware Update--Update**, click “Confirm” to start to upgrade
- ④. The monitor will shut down automatically when finished, please reboot manually
- ⑤. Check whether the latest version

Remark: Please keep the device is powered on in the whole upgrading

10. Technical Parameters

Panel Size	7" IPS (touch)
AG+AF Coating	Haze: 10%±4% Glossiness: ≥70 Light transmittance: ≥83%
Resolution	1920x1080 pixels
Dot Pitch	0.027(H) x 0.081(V) mm
Color Display	1.07B
Color Depth	10bit
Color Gamut	97% DCI-P3
Aspect Ratio	16:9
Brightness	2000cd/m ²

Contrast	1500:1
Viewing Angle	88° /88° (L/R) 88° /88° (U/D)
Backlight	LED
Response Time	Ton+Toff=25ms
Input	SDI (optional), HDMI
output	SDI (optional), HDMI
Audio	3.5mm Stereo Headphone
Power Input	DC IN 12V, Barrel (5.5mm outer, 2.1mm inner); Type-C (PD) 20W
SDI Support Format	720p (60/59.94/50/30/29/25/24/23.98) 1080i (60/59.94/50) 1080p(60/59.94/50/30/29.97/25/24/24sF/23.98/23.98sF)
HDMI Input / Output Support Format	480i/576i/480p/576p 720p(60/59.94/50/30/29/25/24/23.98) 1080i(60/59.94/50) 1080p(60/59.94/50/30/29.97/25/24/23.98) 4K 3840×2160p (60/50/30/29.97/25/24/23.98) 4K 4096×2160p (60/50/30/29.97/25/24/23.98)
Input Voltage	DC7~24V
Power Consumption	≦ 18W
Battery Slot	Dual NP-F battery slots
Unit Size	179Lx110Hx28.6D (mm)
Unit Weight	400g
Mount Points	1/4"-20 Thread Point (top,bottom,right side)
Working Temperature	- 20℃ ~ 50℃
Storage Temperature	- 30℃ ~ 60℃

11. Trouble Shooting

11.1. Only black and white or monochrome picture

- ① please check saturation, brightness & contrast adjustment.
- ② Please check "Check Field" is in black, white or monochrome image or other condition.

11.2. No Image after put on the power

- ① Check if signal cable connecting is in good condition, and if monitor is synchronized with the input signal.
- ② Check signal cable connecting, and make sure to use the standard adapter to connect the monitor. If power is supplied by battery, please check if the battery is fully charged.

11.3. No sound

- ① Check if Volume control does not open, try to increase the volume.
- ② Check the signal input source is normal or not.

■ If there are still other problems, please contact with our related technologists.

★As we are improving product features and product performance, so if there is any change on the specification without prior notice.